

## Sink Phantom Base Copper 30" x 18" (20mm thk)



Kitchen Sinks

Code: 5532 908

PVD Copper  
AISI 304 Stainless steel  
Foster brushed



### DETAILS

**Series** Phantom Base

---

**Coloring** Copper

---

**Finish** PVD

---

**Material** AISI 304 stainless steel

---

**Texture** Foster brushed

---

**Dimensions** 31 <sup>9</sup>/<sub>16</sub>" x 19 <sup>9</sup>/<sub>16</sub>"

---

**Standard fittings** Drain  
Boxed packing

---

**Built-in hole** View technical data sheet

---

Bowl dimension 30" x 18"

---

Number of bowls 1 bowl

---

Waste fitting 3,5" drain

---

## FEATURES

**COPPER** The Copper finish is obtained by treating steel with a physical process called PVD (Physical Vacuum Deposition) which deposits particles of noble metals on the surface. The result is a unique and refined aesthetic effect, and an improvement of the mechanical properties of the steel which is more resistant to impact and scratches.

---

**PHANTOM BASE 20 mm** The Phantom BASE sink's bottoms are specifically engineered to be coupled with sinks made out of slabs. The perimetric trough makes for a simple and perfect installation. This version of Phantom BASE is meant for slabs of 20mm thickness.

---

**PHANTOM BASE WITHOUT WELDING** The steel bottom Phantom BASE solves the problem of water draining of slab sinks, because the slope built into the moulded bottom ensures perfect draining. The radius and sloped profile of Phantom BASE guarantee great practicality and hygiene in everyday cleaning.

---

**High thickness** 1.5 mm thick steel. A significant thickness, which guarantees the maximum sturdiness and durability.

---

**Small radius** Bowls with squared shapes with a modern design and an increased capacity, for a minimal aesthetics connected with an extreme practicality.

---

**Basket 3,5" waste fitting** The drain is equipped with a large 3.5" drain, with the practical basket cap that prevents the discharge of solid parts.

---

## TECHNICAL DATA

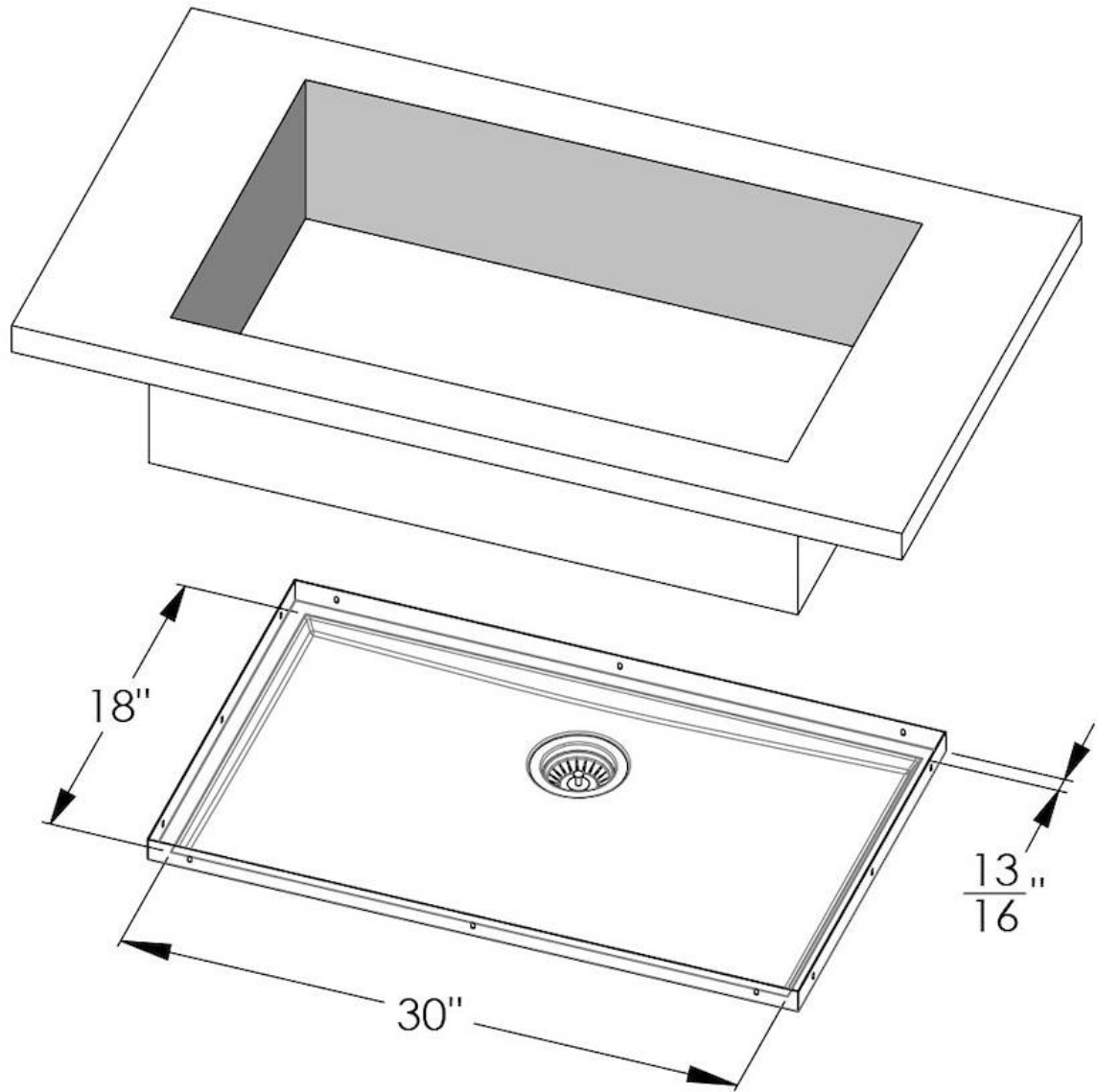

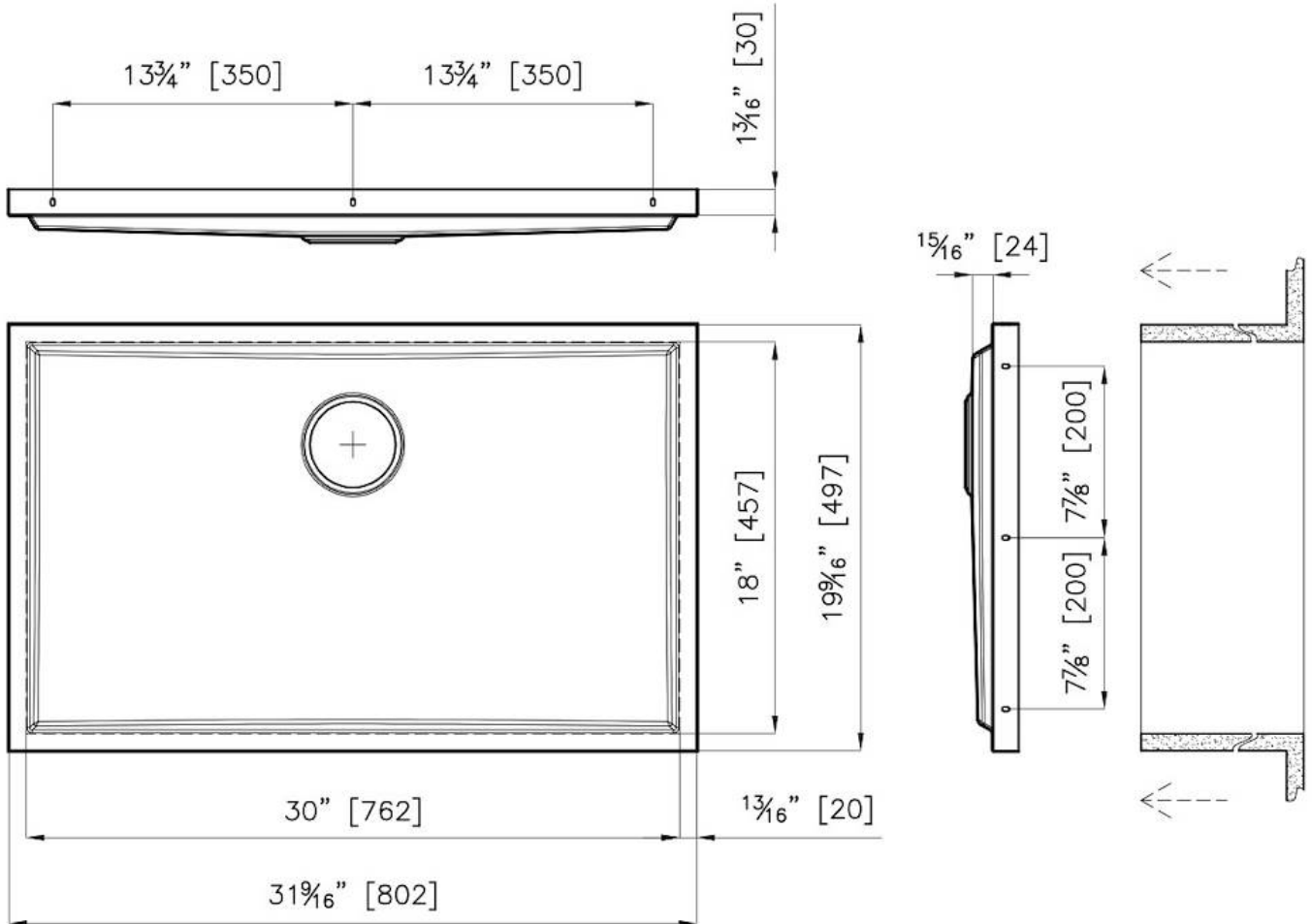

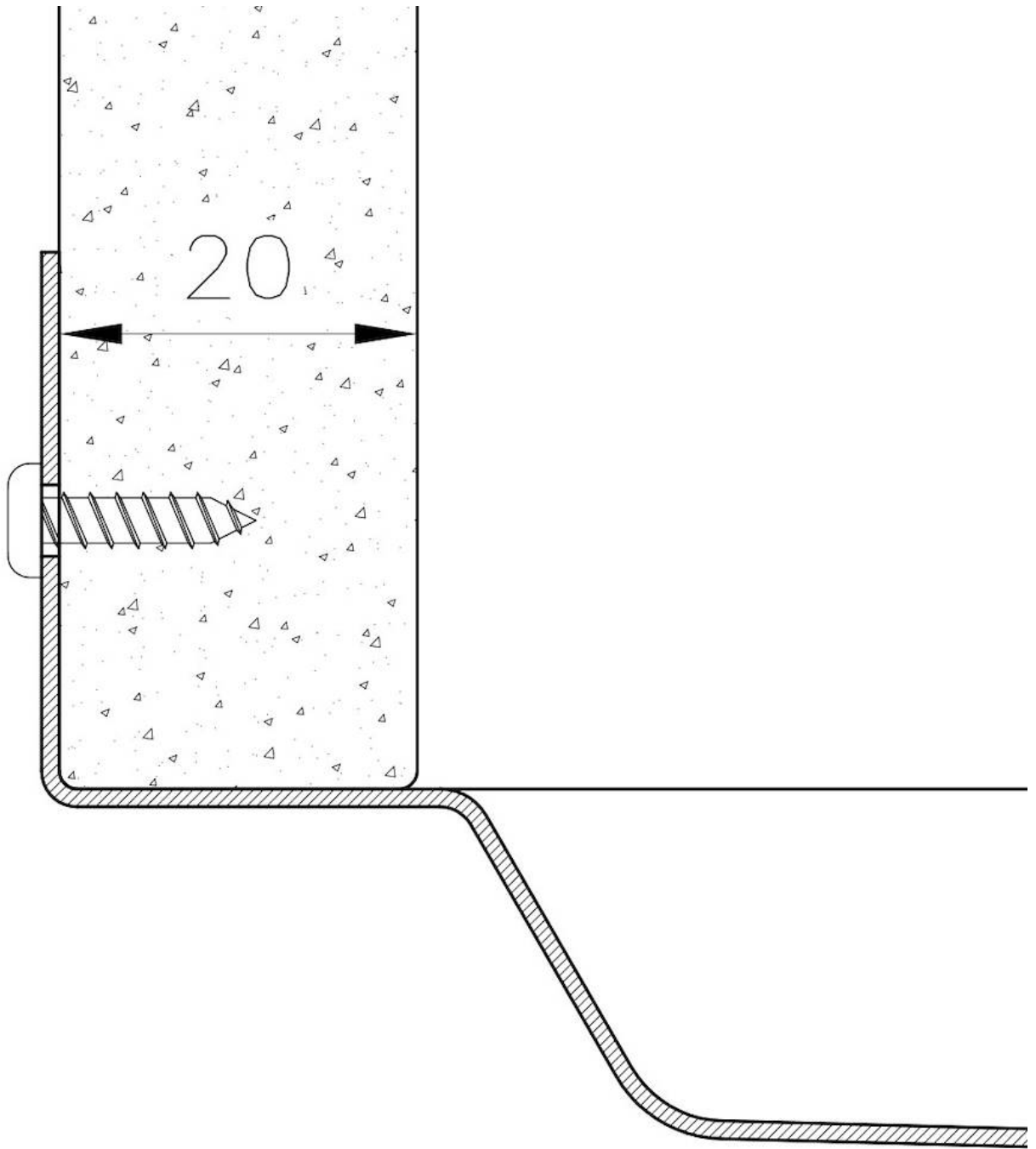

## GALLERY



## OPTIONAL ACCESSORIES



**Black grid**  
8100 619



**Chopping board**  
8644 034



**Stainless steel plate rack**  
8100 154  
\* only in combination with the accessory  
8644 034



**Stainless steel perforated pan**  
8154 000  
\* only in combination with the accessory  
8644 034



**Twin Chopping Board**  
8644 102

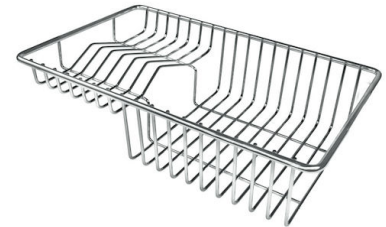

**Stainless Steel dishes holder**  
8100 303  
\* only in combination with the accessory  
8644 102



**Stainless steel perforated pan**  
8151 000  
\* only in combination with the accessory  
8644 102



**Grating kit complete with ring support and food collection tray**  
8159 101  
\* only in combination with the accessory  
8644 102



**Waste disposer throat**  
8669 043

## RECOMMENDED PAIRINGS



**Faucet Capri**  
8467 005



**Faucet Salina**  
8487 005



**Milano Cooktop 4 burners inLine**  
7640 900



**Milano Induction Cooktop 5 Plate**  
7390 945